

SPECIFICATION	VALUE
NO. of PHASES	3
NO. of POLES	4
RATED VOLTAGE(V)	24
RATED CURRENT(A)	3.5±10%
RATED POWER(W)	55
RATED SPEED(RPM)	4000±10%
RATED TORQUE(mN.m)	131
NO LOAD CURRENT(A)	0.3
NO LOAD SPEED(RPM)	6300
SENSOR	HALL SENSOR
INSULATION CLASS	CLASS B
INSULATION RESISTANCE	100MΩ MIN @ 500VDC
DIELECTRIC STRENGTH TEST	500VAC for 1 MINUTE
BEARING TYPE	NMB BALL BEARING, C3

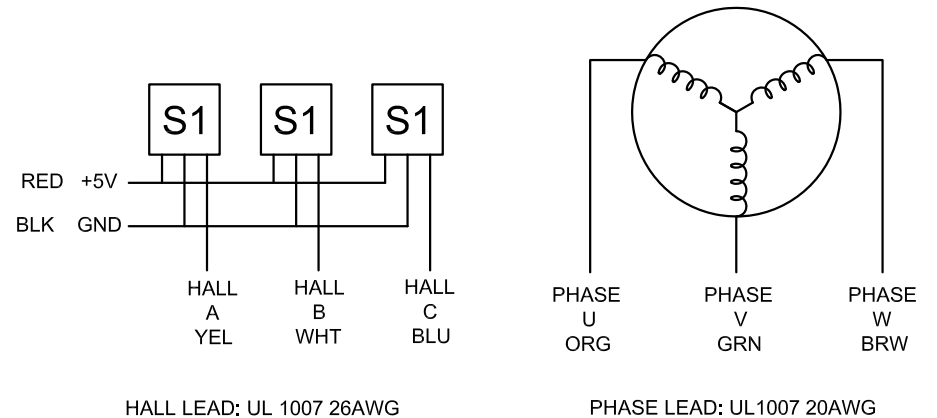

SKYSMotor

	APVD		
	CHKD		
1.5:1	DRN		
SCALE	SIGNATURE	DATE	

BRUSHLESS DC MOTOR

42BLR63-24-01