

User Manual for E6 Series Servo Driver

Driver Parts Name

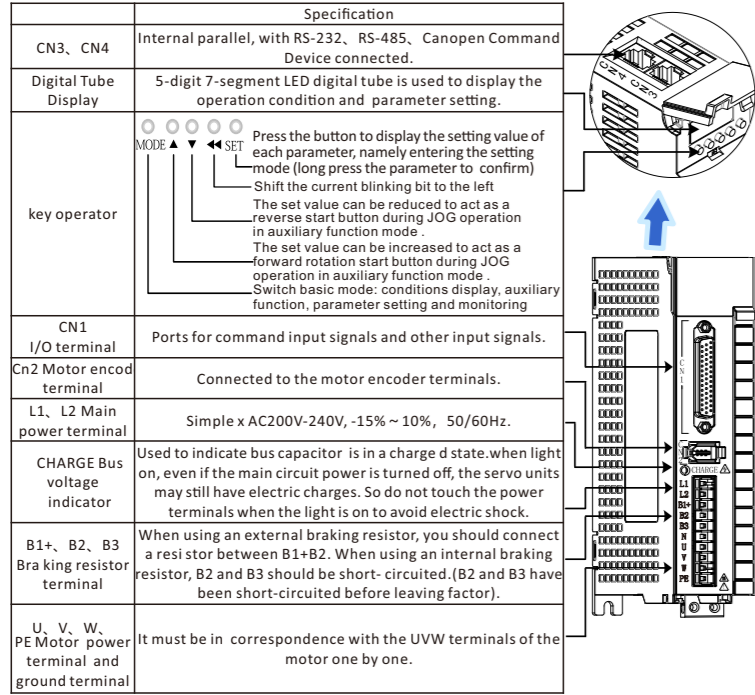

Braking resistor related specifications

Model Type	Built-in braking resistor specifications		Min. Allowed Resistance (Ω)	Max. Braking Energy Absorbed by Capacitor (J)
	Resistance (Ω)	Power(W)		
Single phase 220V	E6-200RS	-	50	9
	E6-400RS	-	45	18
	E6-750RS	50	50	26
	E6-1000RS	50	50	26

Product Specification

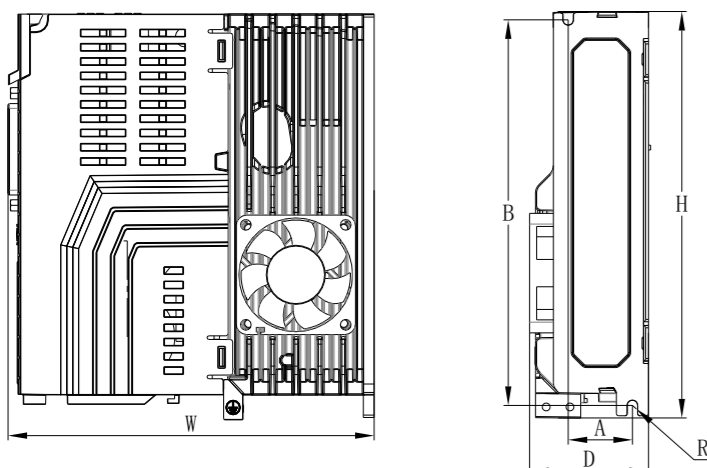

Item	Specification				
	E6 Series	200RS	400RS	750RS	1000RS
Dimension	A(mm)	27			
	B(mm)	162			
	W(mm)	154			
	H(mm)	171			
	D(mm)	51			
	R(mm)	2			
	W(kg)	0.9			
Basic Specifications	Input Power	Single phase AC200V-240V, -15%~10%, 50/60Hz			
	Temperature	Ambient Temperature	0+55°C(from 45°C~to 55°C,keep average load rate within 80%) no freezing		
		Preservation of Ambient Temperature	-20~65°C		
	Humidity	Ambient Humidity	below 20~85%RH (no condensation)		
		Preservation of Ambient Humidity	below 20~85%RH (no condensation)		
	Use and Preservation of Ambient Air	indoor (no direct sunlight), no corrosive gas, flammable gas, oil mist, dust			
	Altitude	below 1000m			
	Vibration	below 5.8m/s ² (0.6G) 10~60Hz(do not use continuously at resonance frequency)			
	Dielectric Withstand Voltage	AC1500V between primary and FG for 1 minute			
	Control Method	three-phase PWM converter sine wave drive			
Encoder Feedback	17bit、23bit (functions as a multi-turn absolute encoder after adding a battery)				
Control Signal	Input	9-way input (DC24V optocoupler isolation) function switching according to the control mode			
	Output	5-way output (DC24V optocoupler isolation, open collector output) switching according to the control mode function			
	Input	2-way input (optocoupler isolation, RS-422 differential, open collector output)			
	Output	4-way output (A/B/Z phase RS-422 differential; Z phase open collector output)			
	RS232 RS-485 CAN	for PC communication (for "Servostudio" connection) for host remote control communication (1:n) CANOPEN bus communication			
Regenerative Functions	Connect regenerative resistor internally or externally pay attention to modifying internal parameters				
Control Modes	6 control modes:speed control,position control,torque control,torque/speed control, speed/position control,torque/position,torque/speed/position mixed control				
Control Input	Alarm reset, proportional action switching, zero fixed function enabling, forward drive prohibited, reverse drive prohibited, external torque limit for forward rotation, external torque limit for reverse rotation, forward jog, reverse jog, forward reset switch, reverse reset switch, origin switch, emergency stop, servo enabling, gain switching				
Control Output	Servo ready, motor rotating, zero speed signal, speed arrival, position arrival, positioning approach signal, torque limit, speed limit, brake output, warning, servo failure, alarm code (3-digit output)				
Position Control	Maximum command pulse frequency	The maximum low speed is 500Kpps, and the pulse width cannot be lower than 1μs; Open collector: maximum 200Kpps, pulse width not less than 2.5μs			
	Input pulse signal form	Differential input; open collector			
	Input pulse signal mode	pulse+direction, right angle phase difference (phase A+phase B), CW+CCW pulse			
	Command pulse frequency division and multiplication (Electronic gear ratio setting)	0.1048576 < B/A < 419430.4			
Pulse output	Command filter	Smooth filter, FIR filter			
	Output pulse form	Phase A and B: differential output Z-phase: differential output or open collector output			
	Frequency division ratio	Arbitrary frequency division			
	Output pulse function	Encoder position pulse and position pulse command (settable)			
Speed Control	Control Input	Servo ON, alarm reset, reverse speed command, zero speed clamping, internal command selection input 1, internal command selection input 2, internal command selection input 3, internal command selection input 4, forward external torque limit input, reverse external torque limit input, emergency stop			
	Control Output	Alarm status, servo ready, brake release, output during torque limit, output during speed limit, speed reached, speed coincidence, motor rotation output, zero speed signal output			
Torque Control	Control Input	Servo ON, alarm reset, torque command reverse, zero speed clamp			
	Control Output	Alarm status, servo preparation, brake release, torque limit, speed limit output, emergency stop			
Torque Command Input	(Factory default setting, range can be set by function code)				
	Speed Limit Function	Positive and negative internal speed limit P03.27, P03.28			
Similarities	Speed Observer Function	Yes			
	Vibration Control function	Yes			
	Adaptive Notch Filter	Yes			
	Auto adjustment function	Yes			
	Encoder output frequency division and multiplication	Yes			
Internal location planning function	Yes				
Adjustment/Function Setting	Use the upper computer to set the software "Servostudio" to adjust				
Protective function	Over voltage, abnormal power supply, over current, overload, abnormal encoder, overspeed, excessive position deviation, abnormal parameters, etc.				

Location Mode Wiring

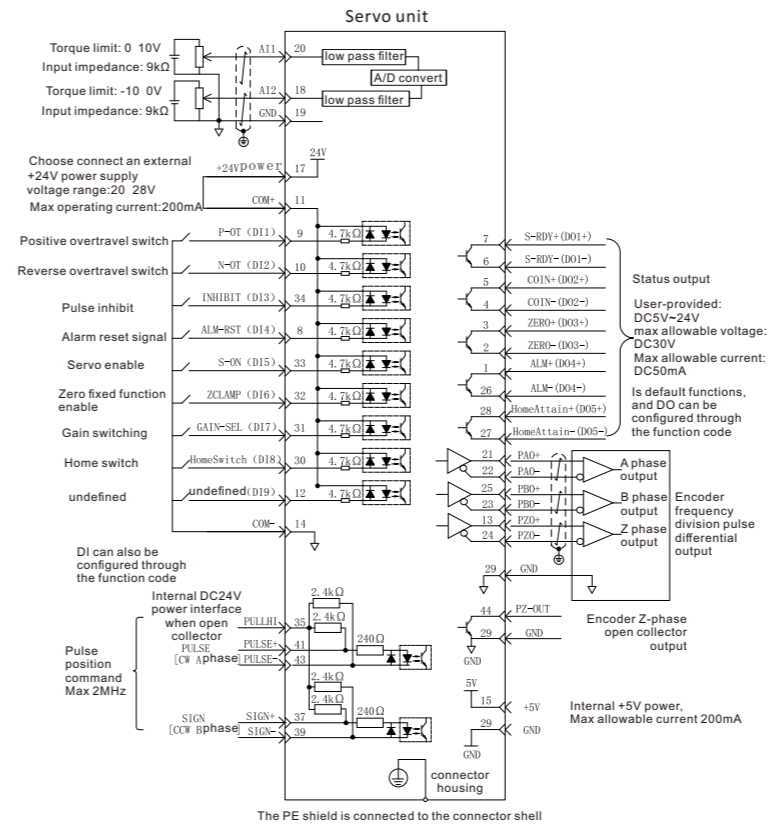

Speed/Torque Control Mode Block Diagram

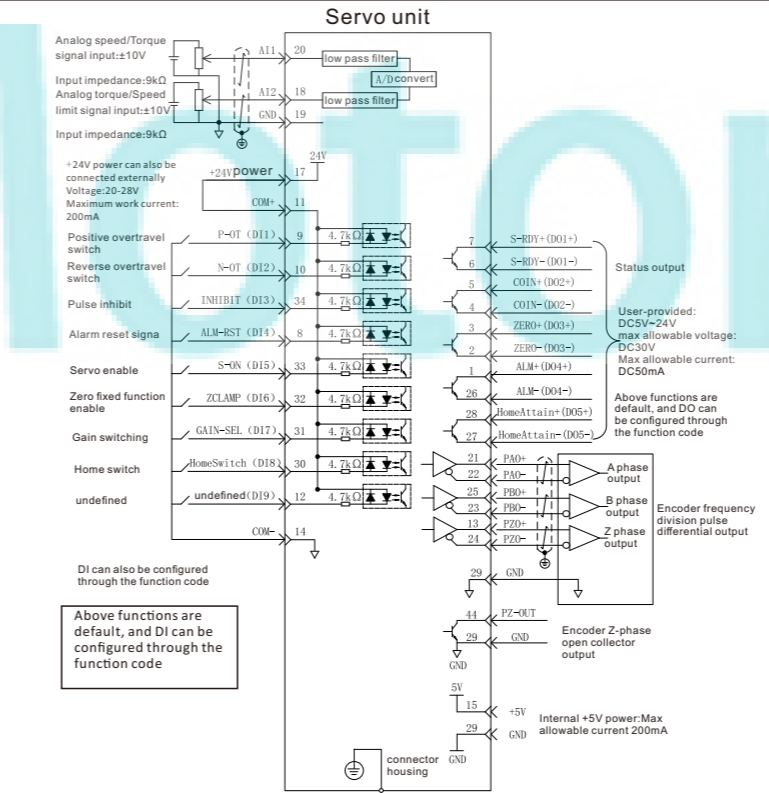

The PE shield is connected to the connector shell.

Indicates twisted pair

Note: ■ Signal cables and power cables must be routed separately, with an interval of at least 30 cm.

- When the signal cable is not long enough to connect the cable, the shielding layer must be connected reliably to ensure reliable shielding and grounding.
- With a reference to GND, when you use +5V, do not exceed the maximum allowable current, otherwise the driver will not work properly.

CN1 Terminal arrangement description

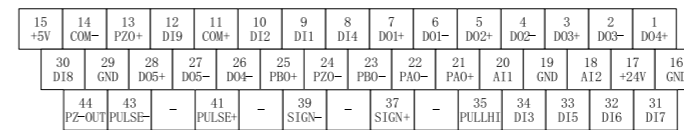

Model type show

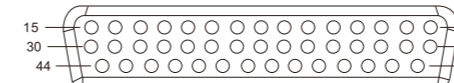

CN2 Illustration of the terminal arrangement of the absolute encoder

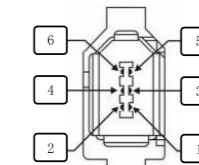

Terminal	Name	Function
1	+5V	PG power+5V
3	-	-
5	PS+	S+ phase
2	OV	Signal
4	-	-
6	PS-	S-phase

CN3, CN4 Illustration of terminal arrangement

Pin	Definition	Description	Terminal Pinout
1	CANH	CAN comm. port	8
2	CANL		
3	CGND	CAN comm. port	7
4	RS485+	RS485 comm. port	6
5	RS485-		
6	RS232-TXD	RS232 Sending end, connected with the receiving end of the host computer	5
7	RS232-RXD	RS232 The receiver is connected to the transmitter of the host computer	4
8	GND	Ground	3
Shell	PE	Ground shield	2

Servo System Wiring

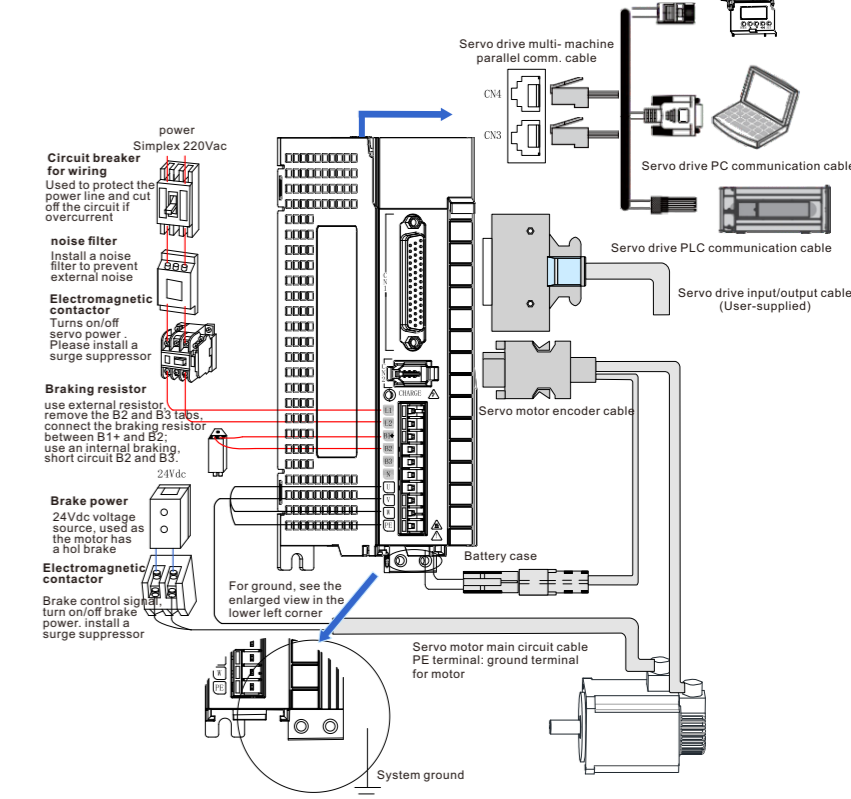

Please pay attention to the power supply capacity when connecting external control power supply or 24Vdc power supply, especially when supplying power to several drives or multiple brakes at the same time, insufficient power supply capacity will lead to insufficient supply current and failure of the drive or the brake. The braking power supply is a 24V DC voltage source. The power should refer to the motor model and meet the braking power requirements.

System wiring precautions:

1. When connecting an external braking resistor, please remove the short-circuit wire between terminals B2 and B3 of the servo drive before connecting. Pay attention to modify the internal parameters.
2. CN3 and CN4 define exactly the same communication interface for the two pins, which can be used arbitrarily between the two.
3. In single-phase 220V wiring, the main circuit terminals are L1 and L2, and the reserved terminals should not be connected.

P02 Group Basic control parameters

Function code	Name	Unit	Factory setting	Effective way	Setting way	Related patterns
P02_00	Control Mode Selection	-	1	Effective immediately	Stop setting	-
P02_01	Absolute value system selection	-	0	Power up again	Stop setting	ALL
P02_02	rotating direction selection	-	0	Power up again	Stop setting	PST
P02_03	Output pulse phase	-	0	Power up again	Stop setting	PST
P02_05	stop model at S-ON off	-	0	Effective immediately	Stop setting	PST
P02_06	Fault No.2 Stop Mode Selection	-	0	Effective immediately	Stop setting	PST
P02_07	Choice of Overhaul Mode	-	1	Effective immediately	Stop setting	PST
P02_08	Fault No.1 Stop Mode Selection	-	0	Effective immediately	Stop setting	PST
P02_09	delay from brake output ON to command received	ms	250	Effective immediately	Run settings	PS
P02_10	delay from brake output OFF to motor de-energized in static state	ms	150	Effective immediately	Run settings	PS
P02_11	motor speed threshold at brake output OFF in rotating state	rpm	30	Effective immediately	Run settings	PS
P02_12	Rotate state, motor does not power to lock output Off delay	ms	500	Effective immediately	Run settings	PS
P02_15	LED Warning Display Select	-	0	Effective immediately	Run settings	PST
P02_18	Servo Enable (S-ON) Filter time constant	ms	0	Effective immediately	Run settings	PST
P02_21	Brake resistance minimum allowed by driver	Ω	-	-	Display	PST
P02_22	Built-in Brake Resistance Power	W	-	-	Display	PST
P02_23	Built-in brake resistance	Ω	-	-	Display	PST

Function code	Name	Unit	Factory setting	Effective way	Setting way	Related patterns
P02 24	Resistance heat dissipation factor	%	30	Effective immediately	Stop setting	PST
P02 25	Brake resistance settings	-	0	Effective immediately	Stop setting	PST
P02 26	External brake resistance power	W	-	Effective immediately	Stop setting	PST
P02 27	External brake resistance resistance	Ω	-	Effective immediately	Stop setting	PST
P02 30	User password	-	0	Power up again	Stop setting	PST
P02 31	System parameter initialization	-	0	Effective immediately	Stop setting	PST
P02 32	Panel Default Display	-	50	Effective immediately	Run settings	-
P02 38	Fault short circuit braking time	ms	5000	Effective immediately	Run settings	PST

P05 Group Position control parameters

Function code	Name	Unit	Factory setting	Effective way	Setting method	Related patterns
P05 00	Location instruction source	-	0	Effective immediately	Stop setting	P
P05 01	Pulse instruction input terminal selection	-	0	Effective immediately	Stop setting	P
P05 02	Number of position instructions per rotation of motor	P/r	0	Power up again	Stop setting	P
P05 04	First-order low-pass filter time constant	ms	0.0	Effective immediately	Stop setting	P
P05 05	Step by step	unit	5.0	Effective immediately	Stop setting	P
P05 06	Average filter time constant	ms	0.0	Effective immediately	Stop setting	P
P05 07	Electronic tooth ratio 1 (Molecules)	-	131072	Effective immediately	Run settings	P
P05 09	Electronic tooth ratio 1 (denominator)	-	10000	Effective immediately	Run settings	P
P05 11	Electronic tooth ratio 2 (Molecules)	-	131072	Effective immediately	Run settings	P
P05 13	Electronic tooth ratio 2 (denominator)	-	10000	Effective immediately	Run settings	P
P05 15	Pulse instruction pattern	-	0	Power up again	Stop setting	P
P05 16	Clear action selection	-	0	Effective immediately	Stop setting	P
P05 17	Number of frequency division pulses	P/r	2500	Power up again	Stop setting	-
P05 19	Speed feedforward control selection	-	1	Effective immediately	Stop setting	P
P05 20	Location Complete Output Condition	-	0	Effective immediately	Run settings	P
P05 21	Location completion threshold	Encoder / Instruction Unit	734	Effective immediately	Run settings	P
P05 22	Positioning proximity threshold	Encoder / Instruction Unit	65535	Effective immediately	Run settings	P
P05 30	Origin Reversion Enable Control	-	0	Effective immediately	Run settings	P
P05 31	Origin Recovery Mode	-	0	Effective immediately	Stop setting	P
P05 32	Speed of high-speed search for origin switch signal	rpm	100	Effective immediately	Run settings	P
P05 33	Speed of low speed search for origin switch signal	rpm	10	Effective immediately	Run settings	P
P05 34	Time of acceleration and deceleration when searching origin	ms	1000	Effective immediately	Stop setting	P
P05 35	Limit the time to find the origin	ms	10000	Effective immediately	Stop setting	P
P05 36	Mechanical origin offset	Instruction unit	0	Effective immediately	Stop setting	P
P05 38	Servo Pulse Output Source Selection	-	0	Power up again	Stop setting	P
P05 39	Electronic gear ratio switching conditions	-	0	Effective immediately	Stop setting	P
P05 40	Mechanical Origin Offset and Limit Treatment	-	0	Effective immediately	Stop setting	P
P05 41	Z Pulse Output Polarity Selection	-	1	Power up again	Stop setting	P
P05 43	Position pulse along selection	1	0	Power up again	Run settings	PST
P05 46	Absolute position linear mode position bias (low 32 bits)	Encoder unit	0	Effective immediately	Stop setting	ALL
P05 48	Absolute position linear mode position bias (high 32 bits)	Encoder unit	0	Effective immediately	Stop setting	ALL
P05 50	Absolute position rotation mode mechanical gear ratio (molecule)	-	65535	Effective immediately	Stop setting	ALL
P05 51	Absolute position rotation mode mechanical gear ratio (denominator)	-	1	Effective immediately	Stop setting	ALL
P05 52	Absolute position rotation mode load rotation cycle number of pulses (low 32 bits)	Encoder unit	0	Effective immediately	Stop setting	ALL
P05 54	Absolute position rotation mode load rotation cycle number of pulses (32 bits high)	Encoder unit	0	Effective immediately	Stop setting	ALL
P05 56	Threshold of zero velocity judgment	rpm	2	Effective immediately	Run settings	P
P05 58	Contact Stop Zero Torque Limit	%	100.0%	Effective immediately	Run settings	P
P05 59	Location Completion Window Time	ms	1	Effective immediately	Run settings	P
P05 60	Positioning completion retention time	ms	0	Effective immediately	Run settings	P
P05 61	Number of divider pulses (32 bits)	P/r	0	Power up again	Stop setting	-
P05 63	Collector Z signal width	μs	0.15	Power up again	Stop setting	P

P06 Group Speed control parameters

Function code	Name	Unit	Factory setting	Effective way	Setting way	Related patterns
P06 00	A Source of Main Speed Instruction	-	0	Effective immediately	Stop setting	S
P06 01	Auxiliary Speed Instruction B Source	-	1	Effective immediately	Stop setting	S
P06 02	Speed Instruction Selection	-	0	Effective immediately	Stop setting	S
P06 03	Speed command keyboard setting	rpm	200	Effective immediately	Run settings	S
P06 04	Set point speed	rpm	100	Effective immediately	Run settings	S
P06 05	Speed command acceleration ramp time constant	ms	0	Effective immediately	Run settings	S
P06 06	Speed command acceleration ramp time constant	ms	0	Effective immediately	Run settings	S
P06 07	Maximum Speed Threshold	rpm	6000	Effective immediately	Run settings	S
P06 08	Forward velocity threshold	rpm	6000	Effective immediately	Run settings	S
P06 09	Reverse velocity threshold	rpm	6000	Effective immediately	Run settings	S
P06 11	Torque Feedforward Control Selection	-	1	Effective immediately	Run settings	S
P06 15	Zero fixed speed threshold	rpm	10	Effective immediately	Run settings	S
P06 16	Motor rotation speed threshold	rpm	20	Effective immediately	Run settings	S
P06 17	Speed consistent signal threshold	rpm	10	Effective immediately	Run settings	S
P06 18	Speed reaches signal threshold	rpm	1000	Effective immediately	Run settings	S
P06 19	Zero speed output signal threshold	rpm	10	Effective immediately	Run settings	S

P07 Group Torque control parameters

Torque instruction 100% corresponding to motor rated torque.

Function code	Name	Unit	Factory setting	Effective way	Setting way	Related patterns
P07 00	A source of master torque instruction	-	0	Effective immediately	Stop setting	T
P07 01	Auxiliary torque instruction B source	-	1	Effective immediately	Stop setting	T
P07 02	Torque Directive Selection	-	0	Effective immediately	Stop setting	T
P07 03	Torque instruction keyboard setting	%	0	Effective immediately	Run settings	T
P07 05	Torque instruction filter time constant	ms	0.79	Effective immediately	Run settings	PST
P07 06	Second torque instruction filtering time constant	ms	0.79	Effective immediately	Run settings	PST
P07 07	Torque limitation sources	-	0	Effective immediately	Stop setting	PST
P07 08	T-LMT selection	-	2	Effective immediately	Stop setting	PST
P07 09	Positive internal torque limit	%	300.0	Effective immediately	Run settings	PST
P07 10	Negative internal torque limit	%	300.0	Effective immediately	Run settings	PST
P07 11	Positive external torque limit	%	300.0	Effective immediately	Run settings	PST
P07 12	Negative External Torque Limit	%	300.0	Effective immediately	Run settings	PST
P07 17	Selection of speed limit sources	-	0	Effective immediately	Run settings	T
P07 18	V-LMT Selection	-	1	Effective immediately	Run settings	T
P07 19	Torque control forward speed limit value / torque control speed limit value 1	rpm	3000	Effective immediately	Run settings	T
P07 20	Negative Speed Limit for Torque Control / Speed Limit for Torque Control 2	rpm	3000	Effective immediately	Run settings	T
P07 21	Torque reaches reference value	%	0.0	Effective immediately	Run settings	PST
P07 22	Torque reaches effective value	%	20.0	Effective immediately	Run settings	PST
P07 23	Torque arrives invalid	%	10.0	Effective immediately	Run settings	PST
P07 40	Speed restricted window in torque mode	ms	1.0	Effective immediately	Run settings	T

P08 Group Gain class parameters

Function code	Name	Unit	Factory setting	Effective way	Setting method	Related patterns
P08 00	speed gain	Hz	25.0	Effective immediately	Run settings	PS
P08 01	Speed loop integral time constant	ms	31.83	Effective immediately	Run settings	PS
P08 02	Position loop gain	Hz	40.0	Effective immediately	Run settings	P
P08 03	Second speed loop gain	Hz	40.0	Effective immediately	Run settings	PS
P08 04	No.2 Speed loop integral time constant	ms	40.0	Effective immediately	Run settings	PS
P08 05	No.2 Position loop gain	Hz	64.0	Effective immediately	Run settings	P
P08 08	Second Gain Mode Settings	-	1	Effective immediately	Run settings	PST
P08 09	Gain switching condition selection	-	0	Effective immediately	Run settings	PST
P08 10	Gain switching delay time	ms	5.0	Effective immediately	Run settings	PST
P08 11	Gain Switching Level	According to switching conditions	50.0	Effective immediately	Run settings	PST
P08 12	Gain switching delay	According to switching conditions	30.0	Effective immediately	Run settings	PST
P08 13	Position gain switching time	ms	3.0	Effective immediately	Run settings	P
P08 15	Load moment of inertia ratio	times	1.00	Effective immediately	Run settings	PST
P08 18	Speed feed filter time constant	ms	0.50	Effective immediately	Run settings	P
P08 19	Speed feedforward gain	%	0.0	Effective immediately	Run settings	P
P08 20	Torque feed filter time constant	ms	0.50	Effective immediately	Stop setting	PS
P08 21	Torque Feedforward Gain	%	0.0	Effective immediately	Run settings	PS
P08 22	Speed Feedback Filter Option	-	0	Effective immediately	Stop setting	PS
P08 23	Speed feedback low pass filter cutoff frequency	Hz	4000	Effective immediately	Run settings	PS
P08 24	Pseudo-differential feedforward control coefficient	-	100.0	Effective immediately	Run settings	PS
P08 27	Friction gain	%	0.0	Effective immediately	Run settings	P
P08 28	Static friction	%	%	Effective immediately	Run settings	P

P09 Group Self-adjusting parameters

Function code	Name	Unit	Factory setting	Effective way	Setting method	Related patterns
P09 00	Self adjustment mode selection	-	0	Effective immediately	Run settings	PST
P09 01	Rigid grade selection	-	12	Effective immediately	Run settings	PST
P09 02	Adaptive Trap Mode Selection	-	0	Effective immediately	Run settings	PST
P09 03	On-line Inertial Identification Mode	-	0	Effective immediately	Run settings	RST
P09 04	Selection of Low Frequency Resonance Suppression Mode	-	0	Effective immediately	Run settings	P
P09 05	Offline Inertial Identification Mode Selection	-	0	Effective immediately	Stop setting	PST
P09 06	Maximum velocity for inertia identification	rpm	500	Effective immediately	Stop setting	PST
P09 07	Acceleration to maximum velocity time constant for inertia identification	ms	125	Effective immediately	Stop setting	PST
P09 08	Waiting time after completion of single inertia identification	ms	800	Effective immediately	Stop setting	PST
P09 09	Complete single inertia identification number of motor turns	r	-	-	Display	PST
P09 12	Group 1 Trap Frequency	Hz	4000	Effective immediately	Run settings	PS
P09 13	Group 1 Trap width rating	-	2	Effective immediately	Run settings	PS
P09 14	Group 1 Trap depth rating	-	0	Effective immediately	Run settings	PS
P09 15	Group 2 Trap Frequency	Hz	4000	Effective immediately	Run settings	PS
P09 16	Group 2 Trap width rating	-	2	Effective immediately	Run settings	PS
P09 17	Group 2 Trap depth rating	-	0	Effective immediately	Run settings	PS
P09 18	Group 3 Trap Frequency	Hz	4000	Effective immediately	Run settings	PS
P09 19	Group 3 Trap width rating	-	2	Effective immediately	Stop setting	PS
P09 20	Group 3 Trap depth rating	-	0	Effective immediately	Run settings	PS
P09 21	Group 4 Trap Frequency	Hz	4000	Effective immediately	Run settings	PS
P09 22	Group 4 Trap width rating	-	2	Effective immediately	Run settings	PS
P09 23	Group 4 Trap depth rating	-	0	Effective immediately	Run settings	PS
P09 24	Resonance Frequency Identification Results	Hz	0	-	Display	PS
P09 30	Torque disturbance compensation gain	%	0.0	Effective immediately	Run settings	PS
P09 31	Time constant of torque disturbance observer filter	ms	0.50	Effective immediately	Run settings	PS
P09 38	Low frequency resonance frequency	Hz	100.0	Effective immediately	Run settings	P

P0B Group Monitoring parameters

Function code	Name	Unit	Factory setting	Effective way	Setting method	Related patterns
P0B 00	Actual motor speed	rpm	-	-	Display	PST
P0B 01	Speed instruction	rpm	-	-	Display	PS
P0B 02	Internal torque instruction (relative to rated torque)	%	-	-	Display	PST
P0B 03	Input signal (DI signal) monitoring	-	-	-	Display	PST
P0B 05	Output signal (DO signal) monitoring	-	-	-	Display	PST
P0B 07	Absolute position counter (32-bit decimal display)	Instruction Unit	-	-	Display	PST
P0B 09	Mechanical angle (number of pulses starting at origin)	Encoder Unit	-	-	Display	PST
P0B 10	Electrical angle	°	-	-	Display	PST
P0B 11	Input position instruction corresponding speed information	rpm	-	-	Display	P
P0B 12	Average load rate	%	-	-	Display	PST
P0B 13	Input instruction pulse counter (32-bit decimal display)	Instruction Unit	-	-	Display	P
P0B 15	Encoder position deviation counter (32-bit decimal display)	Encoder Unit	-	-	Display	P
P0B 17	Feedback pulse counter (32-bit decimal display)	Encoder Unit	-	-	Display	PST
P0B 19	Total power-up time (32-bit decimal display)	s	-	-	Display	PST
P0B 21	Ai1 Sampling 21voltage values	V	-	-	Display	PST
P0B 22	Ai2 Sampling voltage values	V	-	-	Display	PST
P0B 24	Phase current RMS	A	-	-	Display	PST
P0B 26	Bus voltage	V	-	-	Display	PST
P0B 27	Module temperature values	°C	-	-	Display	PST
P0B 33	Failure logging	-	0	Effective	Run	PST
P0B 34	Number of failures selected	-	-	-	Display	PST
P0B 35	Selected fault timestamp	S	-	-	Display	PST
P0B 37	Motor speed at selected faults	rpm	-	-	Display	PST
P0B 38	Electrical U phase current at selected fault	A	-	-	Display	PST
P0B 39	Electrical U phase current at selected fault	A	-	-	Display	PST
P0B 40	Bus voltage at selected fault	V	-	-	Display	PST
P0B 41	Input terminal status at selected fault	-	-	-	Display	PST
P0B 42	Output terminal status at selected fault	-	-	-	Display	PST
P0B 53	Position Deviation Counter	Instruction Unit	-	-	Display	P
P0B 55	Actual motor speed(0.1rpm)	rpm	-	-	Display	PST
P0B 58	Mechanical absolute position (32 bits low)	Encoder Unit	0	-	Display	ALL
P0B 60	Mechanical absolute position (32 bits high)	Encoder Unit	0	-	Display	ALL
P0B 64	Real-time input position instruction counter	Unit of instruction	-	-	Display	PST
P0B 70	Absolute value encoder rotation circle data	r	0	-	Display	ALL
P0B 71	In-circle position of absolute encoder	Encoder Unit	0	-	Display	ALL
P0B 77	Absolute encoder absolute position (low 32 bits)	Encoder Unit	0	-	Display	ALL
P0B 79	Absolute encoder absolute position (high 32 bits)	Encoder Unit	0	-	Display	ALL
P0B 81						