

SPECIFICATION	VALUE
POWER (Kw)	1.5
VOLTAGE (VAC)	110
RATED CURRENT (A)	4
MAXIMUM SPEED (RPM)	24000
FREQUENCY (Hz)	400
NUT MODEL	ER11
COLLET (mm)	Ø6, Ø6.35
RUNOUT OFF (mm)	LESS THAN 0.005
BEARINGS	2x7002C(P4 DT) + 1x7002C(P4)
COOLING	WATER COOLED
MATERIAL	STAINLESS STEEL
LUBRICATION	GREASE
WEIGHT (Kg) [lb]	4.1 [9.04]

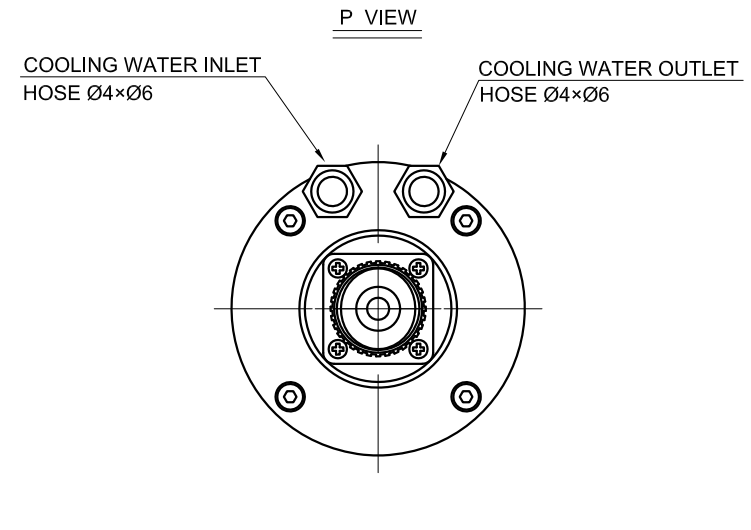

SKYSMotor

mm	APVD	5.5.2019
UNIT	CHKD	
2:1	DRN	
SCALE	SIGNATURE	DATE

SPINDLE MOTOR

GDZ80-1.5A